



MT96

Mini Particle Counter User Manual



Contents	Page no.
1. Introduction	4
2. Features	4
3. Front Panel and Bottom Description	5
4. Specifications	6
5. Power on or Power off	7
6. Measurement Mode	7
7. Setup mode	8
7-1. Date/Time setup	8
7-2. Alarm setup	8
7-3. Sample Time	9
7-4. Unit(°C/°F)setup	9
7-5. Memory View	9
7-6. Mass/Particle setup	10
7-7. Auto Power Off setup	10
8. Shortcut keys	11
9. Product Maintenance	11
10. Cautions	11

1. Introduction

Thank you for purchasing Major Tech's Mini Particle Counter. This Mini Particle Counter with 2.0" color TFT LCD display provides fast, easy and accurate readings for particle counter, particle mass concentration, Air temperature and relative humidity. This product is a practical hand-held instrument on which the real scene and time can be displayed in color on the TFT LCD display. Any memory readings can be recorded in the meter. It is an ideal instrument for environment protection and energy saving.

2. Features

- 2.0" TFT Color LCD display
- 220*176 pixels
- Simultaneously measure PM2.5 and Pm10
- Air temperature and humidity
- Real time clock display
- Analog bar indicator
- Auto Power Off

3. Front Panel and Bottom Description

- 1 - Particle Sensor
- 2 - LCD Display
- 3 - Page up and Setup button
- 4 - Page down and ESC button
- 5 - Power ON/OFF button
- 6 - Measure and Enter button
- 7 - Memory View button
- 8 - USB charge interface
- 9 - Air-bleed hole
- 10 - Bracket fixing hole

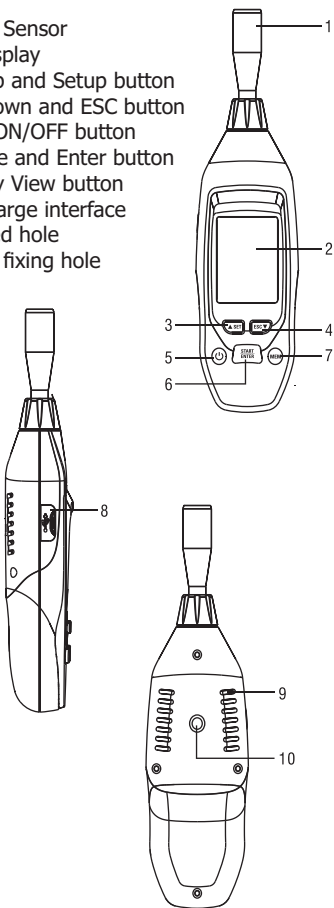

4. Specifications

Particle Counter	
Channel	2.5um, 10um
Mass Concentration	PM2.5: 0 - 2000ug/m ³
	PM10: 0 - 2000ug/m ³
Resolution	1ug/m ³
Air Temperature Measure	
Air Temp Range	0 - 50°C/32 - 122°F
Resolution	0.1°C/°F
Basic Accuracy	± 1°C/ 2°F
Humidity Range	0 to 100%RH
Resolution	0.1%RH
Basic Accuracy	±5%RH 0 - 20%RH 80 - 100%RH
	±3.5%RH 20 - 80%RH

5. Power on or Power off

On the power off mode, press and hold  button, until the LCD is on, then the unit will power on.

On the power on mode, press and hold  button, until the LCD is off, then the unit will power off.

6. Measurement Mode

On the power on mode, press the  button to start measuring PM2.5 and PM10, the top left corner of the LCD display "Counting", the top right corner of the LCD display count down, LCD main display PM2.5 and PM10 data and temperature & humidity readings are at the bottom of the LCD.

Press the button again to stop the measurement, the top left corner of the LCD will display "Stopped", the LCD will display the last measurement of data.

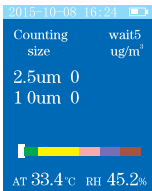

Data will be automatically saved to the instrument memory, which can store up to 5000 data.





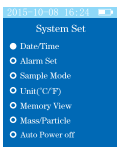

7. Setup mode

Powering on the instrument, Long press button  to enter into the system setup mode when not do measurement operation, as shown below:



Press the  button and the  button to select the menu option needed, then press button  to enter into the appropriate settings page.

7-1.Date/Time setup

After entering into Date/Time setup mode, press  button and  button to select the value, press  button to set next value. After completing the setup, please press button  to exit time setting mode and returns to the system settings mode.

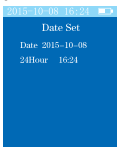

7-2.Alarm setup

Press  button and  button to activate or deactivate alarm function.



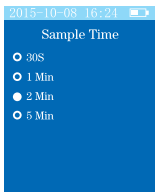

7-3.Sample Time

Press  button and the  button to select the sampling time, sampling time can be select by 30s,1min,2min or 5min.



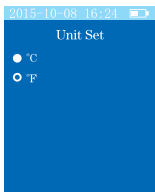

7-4.Unit(°C/°F)setup

Press  button and the  button to select the temperature unit (0C/°F).



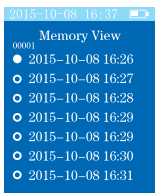

7-5.Memory View

Press  button and the  button to select storage catalogue, press  button to view data in selected storage catalog. 5000 sets of data can be stored in the instrument.



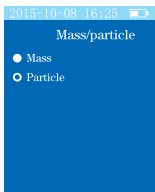

7-6. Mass/Particle setup

Press  button and the  button to select the mode particle concentration and mass concentration mode.



7-7. Auto Power Off setup

Press  button and the  button to set the auto-off time.

Disable: Power off function is deactivated.

3MIN:

Automatically shutdown in 3 minutes without any operations.

10MIN:



Automatically shutdown in 10 minutes without any operations.

30MIN:

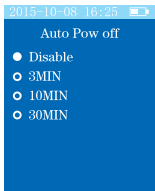
Automatically shutdown in 30 minutes without any operations.



8. Shortcut keys

Press the  button to quickly enter the storage data directory view, select the directory button to view the specific data. In the main LCD interface, press and hold the  button then press the  button until the sound of a buzzer delete the stored data.

9. Product Maintenance

- Maintenance or service is not included in this manual, the product must be repaired by professionals
- It must use the required replacement parts in maintenance
- If the operating manual is changed, please instruments prevail without notice.

10. Cautions

- Do not use in over dirty or dusty environment. Inhalation of too many particles will damage the product.
- To ensure the measure accuracy, please do not use in an over fogged environment.
- Do not use in explosive environment.
- Do not open the instrument as opening it will void any and all warranties.



Rev. 150505

MAJOR TECH

(PTY) LTD

**T9 Industrial Village, 7 Sam Green Road,
Tunney Ext. 9, Elandsfontein,
South Africa**

**P.O. Box 888, Isando 1600,
South Africa**

Telephone: +27 11 872 5500

National Contact Number: 08 61 62 5678

E-mail: sales@major-tech.com



www.major-tech.com

