



**INSTRUCTION MANUAL**  
**DNS16**  
**16A Day/ Night Sensor**  
**with Timer**



## 1. INTRODUCTION

The DNS16 day-night sensor automatically adjusts lighting based on ambient light levels and preset schedules. It features adjustable lux sensitivity and customizable timer settings. With a robust 16A rated current and IP66 waterproof rating, it integrates easily into both new and existing installations. Ideal for outdoor lighting, streetlights, and security systems, it enhances energy efficiency and security by activating lights only when necessary. Its unique wall-box design with six knockouts allows for flexible installation. Simple yet effective, the DNS16 is the perfect solution for automated lighting control. Installation should be performed by a qualified professional.

## 2. SPECIFICATIONS

Function	Range
Rated Current	16A Max
Rated voltage	220-240V AC
Frequency	50/60Hz
Ambient Light	<3 - 50 Lux (Adjustable)
Working Humidity	<93% RH
Installation	Surface Mount on Walls or Ceilings
Built-in Timer Settings	1, 2, 3, 4, 5, 6, 7, 8, 9 Hours & Dusk to Dawn
Working Temperature	-20°C to 40°C
Warranty	5 years - Limited
Standards	IEC 60669-1, IEC 60669-2-1 AS/NZS 60669.1, AS/NZS 60669.2.1

## 3. INSTALLATION ADVICE

### Note:

- There should be no obstruction affecting natural light in front of the sensor.
- There should be no swaying objects in front of the sensor.
- Avoid installing the sensor under the light or in the place where light will irradiate to the sensor.

## 4. CONNECTION

**WARNING: Danger of Death Through Electrical Shock**



- Must be installed by professional electrician.
- Disconnect power source.
- Cover or shield any adjacent live components.
- Ensure device cannot be switched on.
- Check power supply is disconnected.

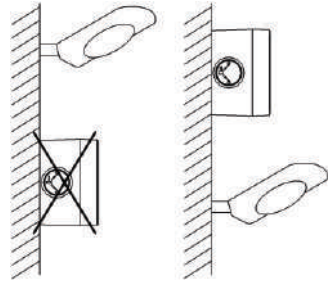

1. Ensure power supply is turned off
2. Loosen the screws and remove the front cover (refer to fig. 1)
3. Remove the necessary knock outs for 1 x for power supply and 1 each for up to 5 separate loads (refer to figures 2 & 3)
4. Fit the necessary glands to the removed knock outs (refer to figures 4& 5)
5. Identify the ideal placement and use the back housing of the sensor as a guide, to ensure proper placement.
6. Mark and drill holes for the screws and fischer plugs and secure the box to the installation surface
7. Connect all loads through the knock outs and glands (up to 5 loads can be connected)
8. Insert power supply, through the closest knock out.
9. Connect the power cable into the terminal block as per the wiring diagram (refer to 6. Wiring Diagram).
10. Once all connections are complete, replace and fasten the front cover using the included screws and screw caps (refer to figures 6 & 7)
11. Once installation is complete, turn on the power to test.

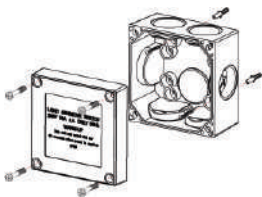

Figure 1

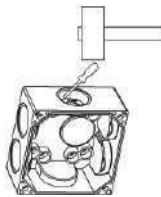

Figure 2

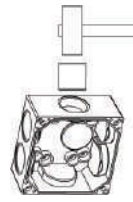

Figure 3

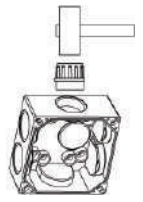

Figure 4

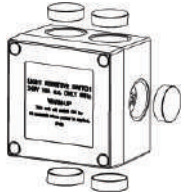

Figure 5

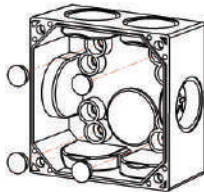

Figure 6

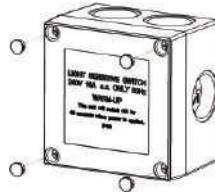

Figure 7

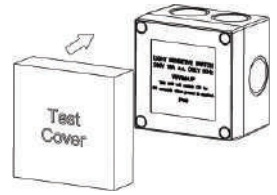
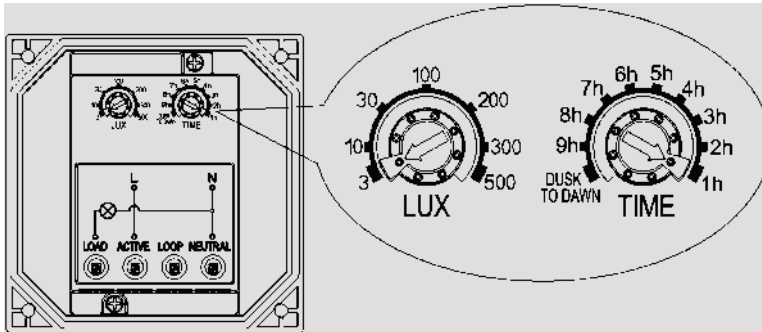

Figure 8

## 5. TEST

- Set the Lux setting to position "3" and Switch the power on.
- For daytime testing, cover the sensor with a black cloth, box or any opaque test cover (refer to figure 8).
- Cover the detection window of the sensor, the ambient light picked up by the sensor will be dark and the connected loads should switch on.
- Remove the cover after testing, they connected loads should automatically switch off.



## 6. WIRING DIAGRAM

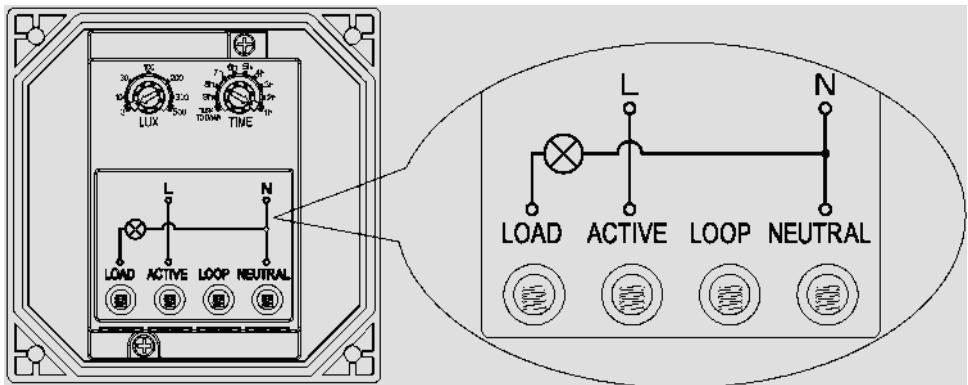

## 7. PROBLEMS AND SOLUTIONS

### The load does not work:

- Ensure the connection to the power source and load is correct.
- Check if the load is in working order.
- Check if the sensor settings corresponds with the ambient light conditions.

### The sensitivity is poor:

- Check if there is any hindrance in front of the detector which may interfere with its ability to sense ambient light.
- Check that the ambient temperature is below 40°C.

### The sensor cannot shut off the load automatically:

- Check if there is an object casting a shadow or blocking ambient light.
- Confirm that the power supply is between 220V and 240V AC.



---

# ***MAJOR TECH (PTY) LTD***

**South Africa**

 [www.major-tech.com](http://www.major-tech.com)

 [sales@major-tech.com](mailto:sales@major-tech.com)

**Australia**

 [www.majortech.com.au](http://www.majortech.com.au)

 [info@majortech.com.au](mailto:info@majortech.com.au)

